

















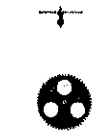
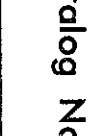





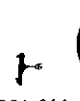

Cal. 6309A

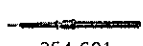

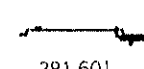
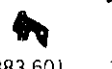
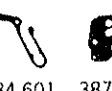

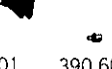
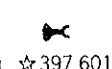
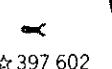



Characteristics

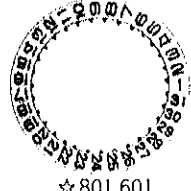

Casing diameter : 27.0 φ mm
 Maximum height : 5.2 mm
 Vibration per hour : 21,600
 Automatic winding with sweep second
 Calendar (day & date)
 Instant setting device for day & date calendar
 "Diashock" Shock Resistant Device









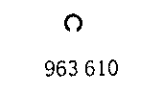
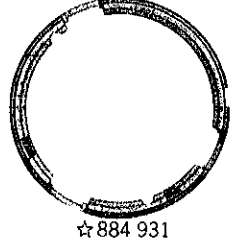



















































Catalog No.

☆⇒ Please see remarks.

Calibre No.	6309A	Jewels	17j	Style Name
PART NO.	PART NAME	PART NO.	PART NAME	
112 601	Barrel & train wheel bridge	014 365	Diashock hole jewel with frame	
122 602	Center wheel bridge	022 257	Center wheel bridge screw	
161 805	Pallet cock	022 257	Setting lever spring screw	
171 611	Balance cock	022 458	Screw for oscillating weight	
193 601	Framework for automatic device with ball-bearing	022 467	Ratchet wheel screw	
		022 468	Pallet cock screw	
		022 468	Framework screw for automatic device with ball-bearing	
205 613	Complete barrel with arbor	022 468	Date driving wheel screw	
213 612	Barrel arbor	022 491	Minute wheel bridge screw	
221 611	Center wheel & pinion	022 493	Barrel & train wheel bridge screw	
225 611	Cannon pinion	022 493	Balance cock screw	
231 601	Third wheel & pinion	022 760	Date dial guard screw	
241 611	Fourth wheel & pinion	022 760	Day jumper screw	
251 611	Escape wheel & pinion	022 761	Dial screw	
261 611	Minute wheel	022 160	Stud screw	
271 611	Hour wheel	023 039	Tube for framework screw of automatic device	
282 601	Clutch wheel	023 040	Tube for pallet cock screw (recessed type)	
285 611	Ratchet wheel	023 150	Tube for pallet cock screw (cylinder type)	
301 611	Jewelled pallet fork & staff	023 151	Tube for barrel & train wheel bridge screw	
311 601	Balance complete			
341 601	Regulator			
345 601	Stud holder			
354 601	Winding stem			
381 601	Click			
383 601	Setting lever			
384 601	Yoke (Clutch lever)			
387 601	Minute wheel bridge			
388 601	Setting lever spring			
390 601	Setting lever axle			
☆397 601	Lever for unlocking stem A			
☆397 602	Lever for unlocking stem B			
401 615	Mainspring with slipping attachment			
☆500 601	Oscillating weight			
505 601	Transmission wheel			
☆801 601	Date dial			
802 601	Date driving wheel			
803 601	Setting wheel lever complete			
808 601	Date dial guard A			
810 601	Date jumper			
817 611	Intermediate date wheel			
831 611	Pawl lever with jewel			
839 601	Holder for transmission wheel & pawl lever			
868 601	Day finger			
☆870 510	Day star with dial disk			
873 601	Day jumper			
963 610	Snap for day star with dial disk			
☆884 931	Holding ring for dial			
011 145	Upper hole jewel for center wheel			
011 146	Lower hole jewel for center wheel			
011 147	Upper hole jewel for transmission wheel			
011 210	Diashock cap jewel			
011 406	Upper hole jewel for escape wheel			
011 406	Lower hole jewel for escape wheel			
011 503	Upper hole jewel for pallet			
011 532	Lower hole jewel for third wheel			
011 723	Lower hole jewel for pallet			
011 724	Lower hole jewel for transmission wheel			
014 317	Diashock spring			
014 363	Diashock upper frame			
014 364	Diashock lower frame			

☆⇒ Please see remarks on the next page.

Calibre No. 6309A	Jewels 17j	Style Name
-----------------------------	----------------------	------------

Remarks :

Lever for unlocking stem

- ☆397 601.....Used for the one-piece type case with the dial whose external diameter is **27mm** or longer.
(When the dial is shaped other than round, the radius is to be measured in the direction of the lever for unlocking stem.)
- ☆397 602.....Used for the one-piece type case with the dial whose external diameter is less than **27mm**.
(When the dial is shaped other than round, the radius is to be measured in the direction of the lever for unlocking stem.)

Date dial

- ☆801 601 (Black figures on white background).....Used when both the crown and the calendar frame are located at **3 o'clock** position.

If any other type of date dial is required, specify ① Cal. No. ② the crown position ③ the calendar frame position and ④ the dial No.

Day star with dial disk

- ☆870 510(English↔Spanish).....Used when both the crown and the calendar frame are located at **3 o'clock** position.

If any other type of day star with dial disk is required, specify the number printed on the disk.

Holding ring for dial

- ☆884 931.....The type of a holding ring for dial is determined based on the design of cases and dials.
Check the case number and refer to "**SEIKO Casing Parts List**" to choose a corresponding holding ring for dial.

Oscillating weight

- ☆500 601.....This oscillating weight is interchangeable with the one for movements of calibre 61 series listed below, and the interchangeability is limited within the listed calibres.

Oscillating weight Cal. No.	500 620	500 622	500 601
6105 A & B			
6106 B & C			
6117 A & B	V	V	V
6118A			
6119 B & C			
6109A	V	V	V
63 Series	—	—	V

V : Interchangeable
— : Not interchangeable

Form of oscillating weight

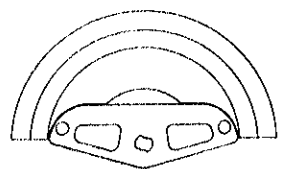

500 620

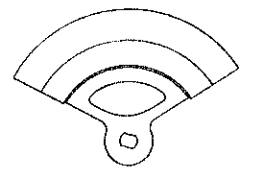

500 622

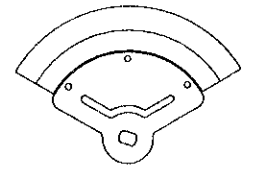

500 601

1) Specifications

Casing diameter: ϕ 27.0 mm
 Height: 5.2 mm
 Vibrations per hour: 21,600
 Automatic winding
 Calendar mechanism: Day and date, bilingual change-over system for the day of the week, instant day and date setting device

2) Features

- **Highly reliable movement**
The highly stabilized accuracy and high reliability established for the 61 series has been incorporated into the movement.
- **Easy-to-use day/date setting device**
All that is required for day-date correction is to turn the crown. Turn clockwise (away from you) for date setting; turn counter clockwise (towards you) for day setting.
- **Easy after-servicing**
Disassembling and reassembling procedures and serviceability have been improved largely by:
 - employment of a new balance hair-spring holding device;
 - decrease in number of parts resulting from the simplification of the movement structure;
 - decrease in number of new parts resulting from interchangeability of some parts with Cal. 61 series.

3) Disassembling and reassembling

Disassembling procedures Figs.: ① ~ ⑤⑦
 Reassembling procedures Figs.: ⑤⑦ ~ ①
 The movement holder for 61 series is also used for disassembling and reassembling.

4) Lubrication

The following marks indicate the types of oil, and quantity to be applied and lubricating portions.

Type of oil

- Moebius A
- Moebius V
- SEIKO Watch Oil, S-2
- SEIKO Watch Oil, S-6

Oil quantity

- Liberal quantity
- Normal quantity
- Extremely small quantity

Note: Never lubricate the portions marked ⊗

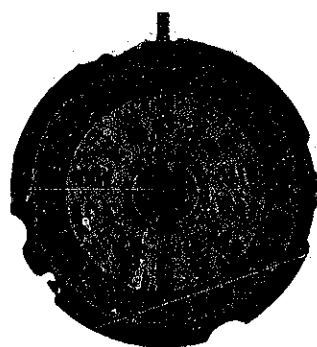
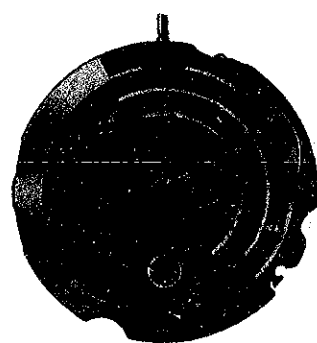

Movement

Holding ring for dial

As this holding ring for the dial incorporates the two functions of both the currently used holding ring for dial and the case ring, it simplifies the casing of the watch.

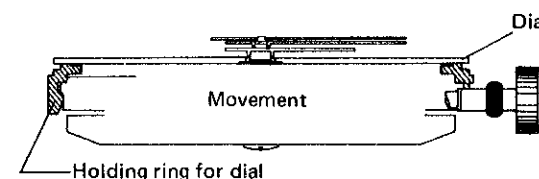

The holding ring for dial is generally classified into two types.

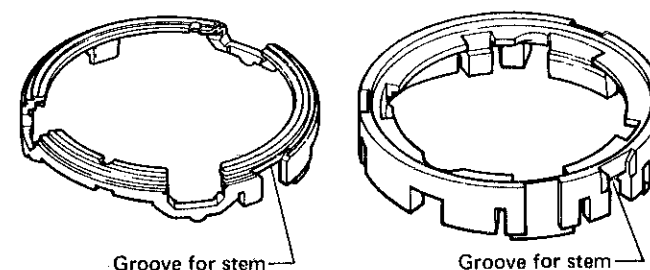

Note:

- The movement holder for 61 series cannot be used if the holding ring for dial is assembled with the movement, because the holding ring for dial touches when setting the movement into the movement holder as shown in the illustration. (The movement holder for 61 series can be used for the one-piece type case, square type case and case with dial ring.)

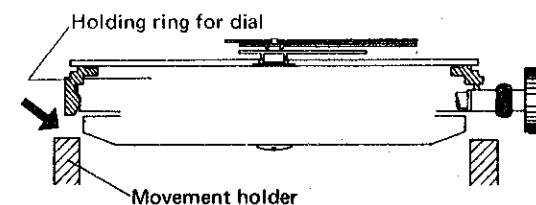

The holding ring for dial touches when setting the movement into the movement holder.

- Disassembling and reassembling of this holding ring for dial from the movement is a little different from that of the current holding ring for dial. Follow the procedures below.

Disassembling

- When the movement is to be removed from the case, pull out the winding stem and turn the case upside down. The movement should fall out. It is not necessary to pull up on the holding ring for dial.

- After loosening the dial screws, the dial and the holding ring for dial can be removed together. Put the tip of tweezers into the groove of the main plate located near the barrel and pry toward the arrow marked direction as shown in the illustration. Then the dial and the holding ring for dial will be removed together.

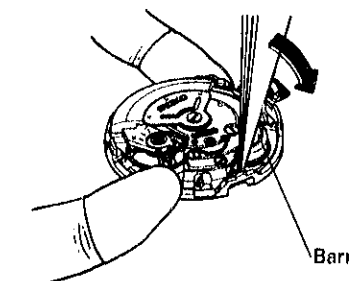

Reassembling

- Place the groove for the stem of the holding ring for dial upon the winding stem, and press down the holding ring for dial on the mainplate.
- Place the movement on a clean cloth when handling.

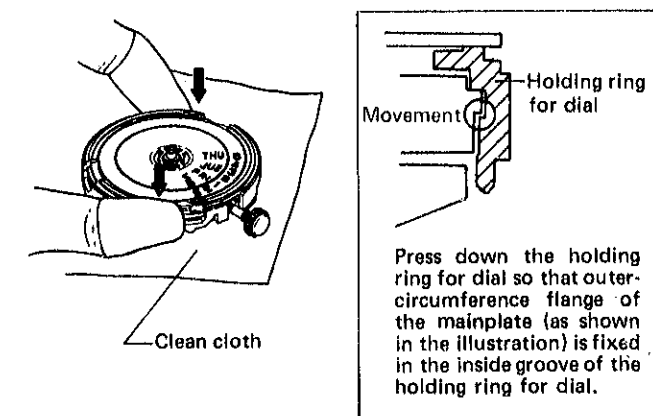

Hour, minute and second hands

Note for reassembling:

- When mounting the hands, place the movement on a clean cloth.

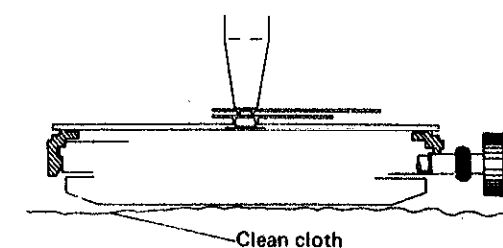

6309A Calendar mechanism

6309A Automatic winding mechanism, escapement and governor mechanism

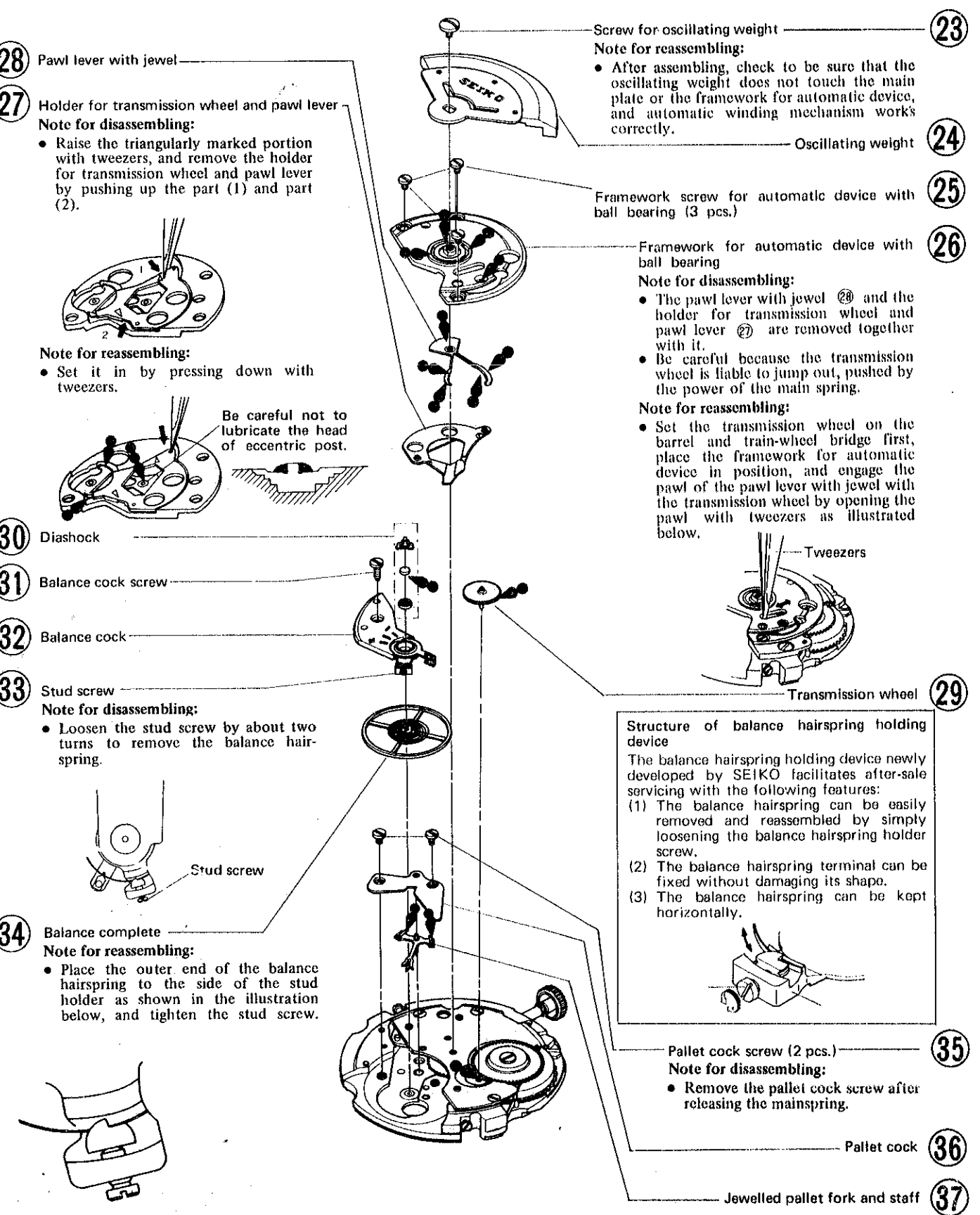
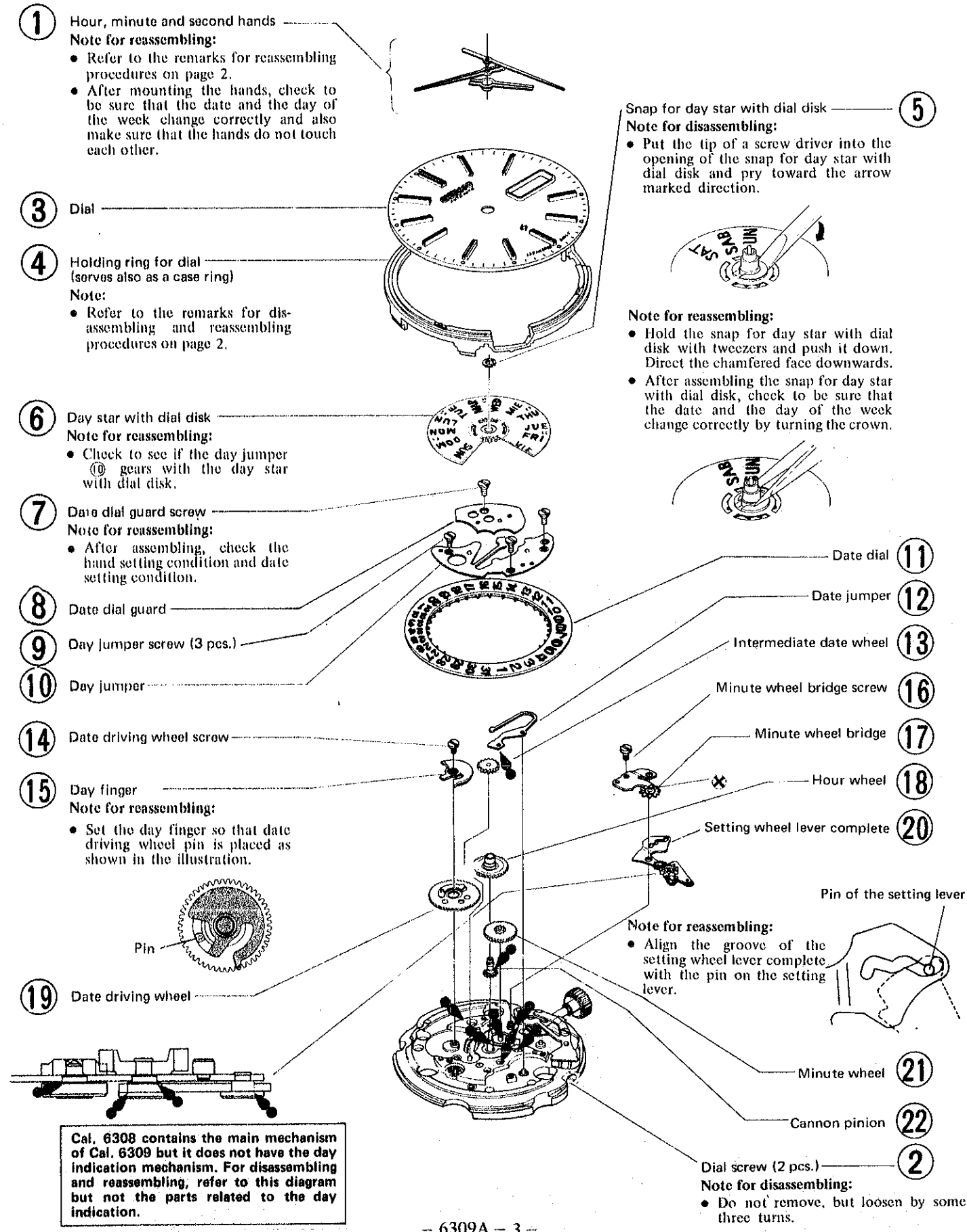

6309A Gear train mechanism

6309A Setting mechanism

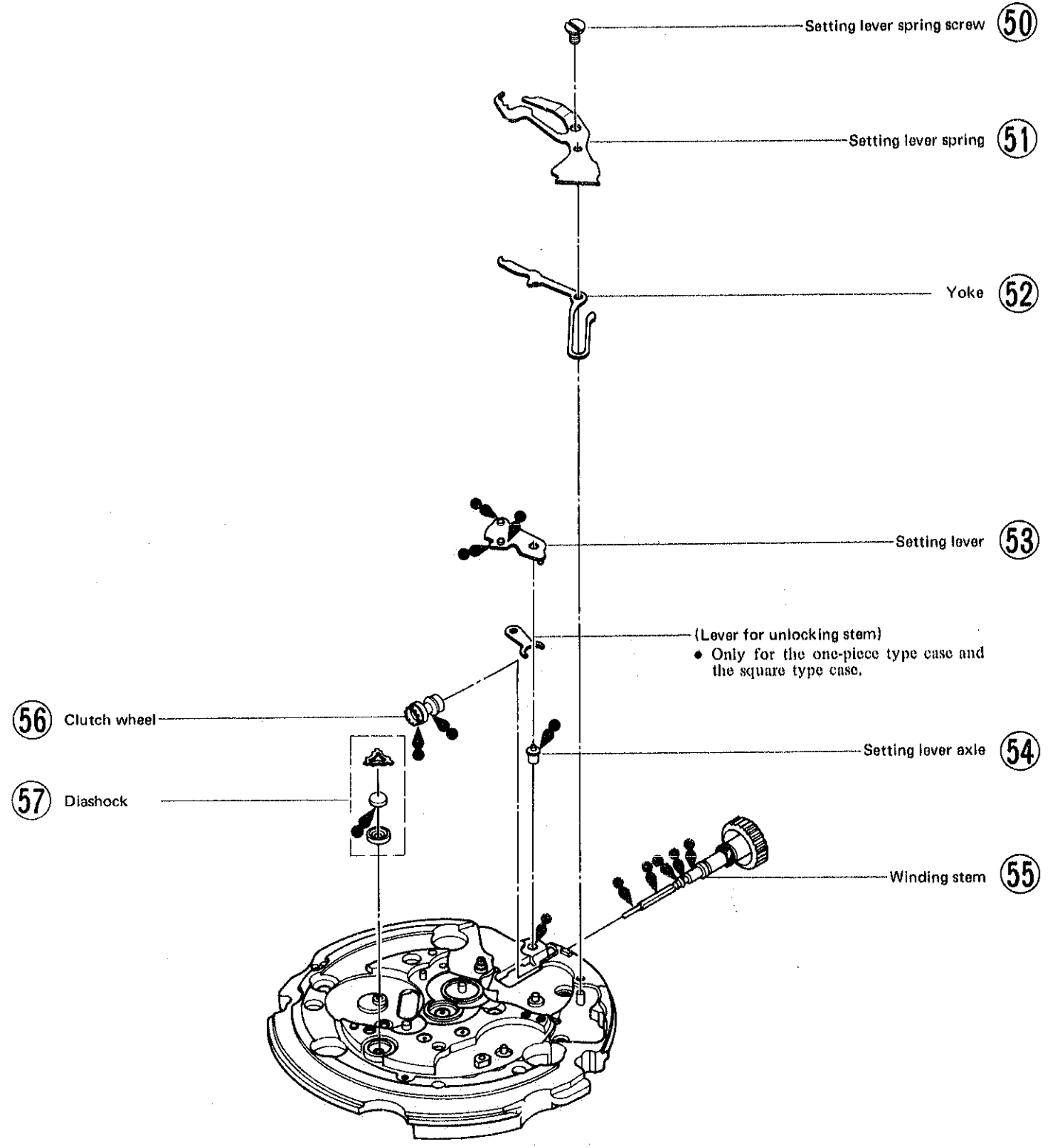
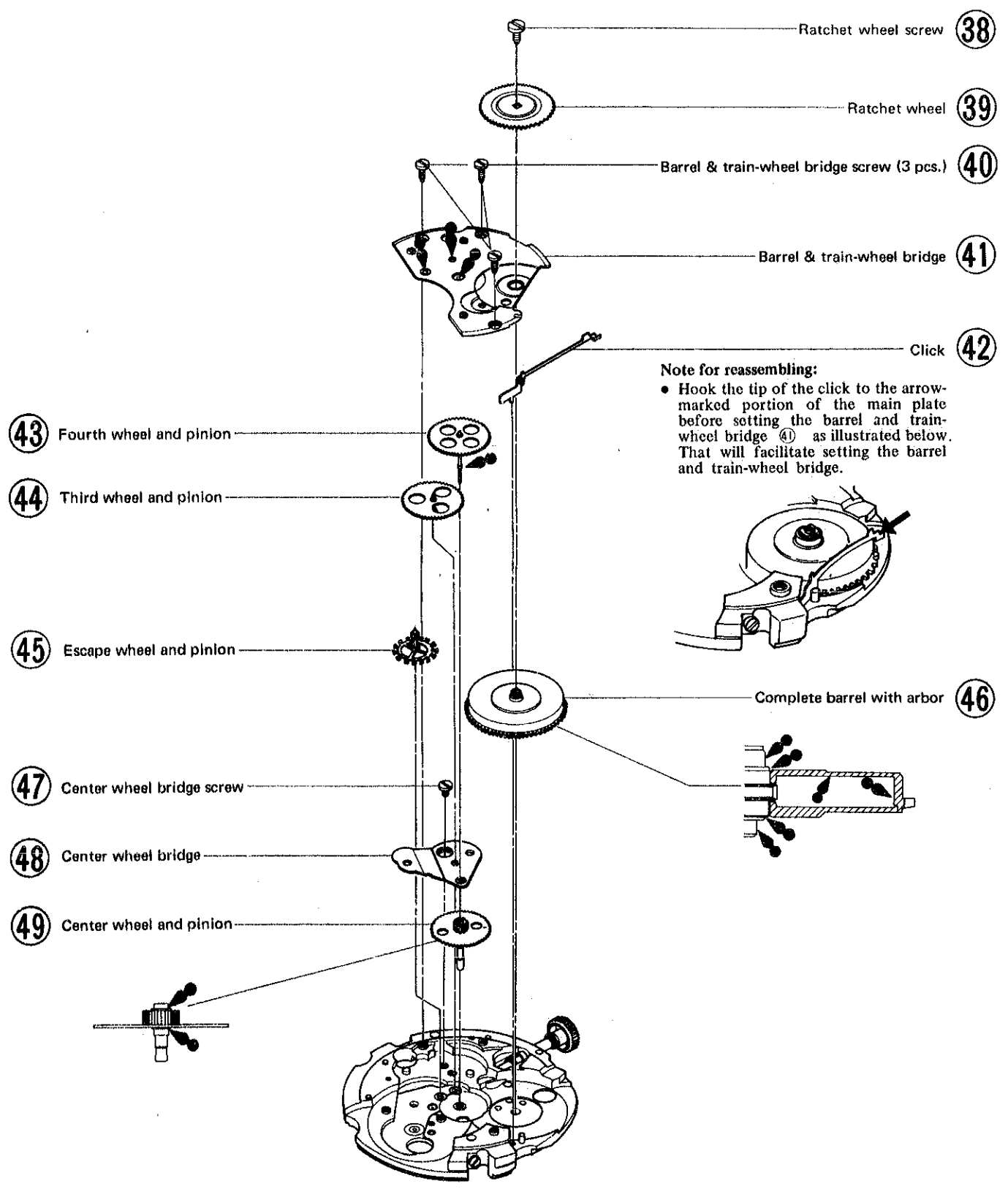

6309A Setting mechanism

Crown at the normal position (free)

The clutch wheel and the setting wheel do not gear with each other, and no power can be transmitted to the mainspring by turning the crown.

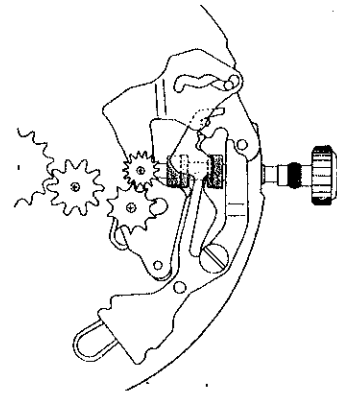

Crown at the first click position (for day/date setting)

(1) Clockwise turning (date setting)

Turn the crown clockwise, and the corrector wheel will move toward the date dial and it will gear with the date dial to correct the date.

The turning force is transmitted from the Crown, Clutch Wheel, Setting Wheel, Intermediate Setting Wheel, Corrector Wheel and Date Dial.

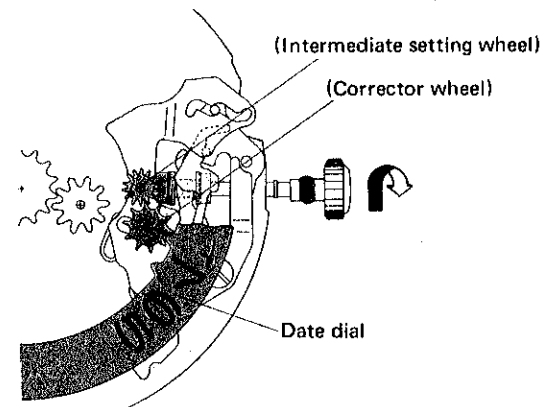

(2) Counterclockwise turning (day setting)

Turn the crown counterclockwise, and the corrector wheel will move toward the day star with dial disk and it will gear with the intermediate wheel for day correction to the day.

The turning force is transmitted from the Crown, Clutch Wheel, Setting Wheel, Intermediate Setting Wheel, Corrector Wheel, Intermediate Wheel for Day Correction and Day Star with Dial Disk.

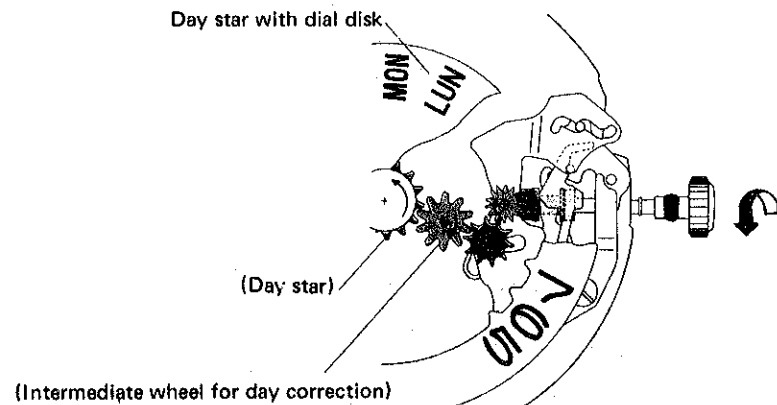

Crown at the second click position (for hand setting)

The setting wheel lever complete will move toward the minute wheel through the function of the setting lever and the intermediate setting wheel will gear with the minute wheel to set the hands.

At the same time, this motion of the setting wheel lever complete is transmitted to the day-date corrector wheel rocking lever and, the corrector wheel moves into a neutral position so that it will not gear with either the date dial and the intermediate wheel for day correction.

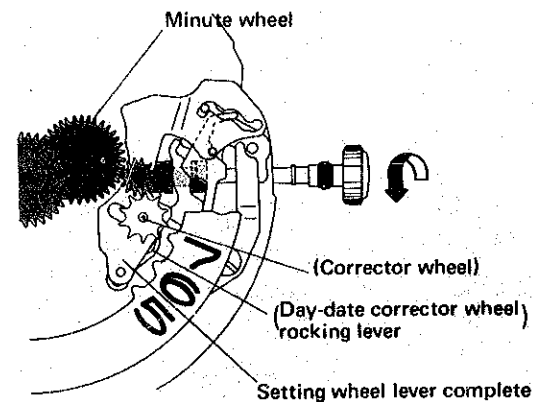

1) Specifications

Casing diameter: ϕ 27.0 mm
 Height: 5.2 mm
 Vibrations per hour: 21,600
 Automatic winding
 Calendar mechanism: Day and date, bilingual change-over system for the day of the week, instant day and date setting device

2) Features

- **Highly reliable movement**
 The highly stabilized accuracy and high reliability established for the 61 series has been incorporated into the movement.
- **Easy-to-use day/date setting device**
 All that is required for day-date correction is to turn the crown. Turn clockwise (away from you) for date setting; turn counter clockwise (towards you) for day setting.
- **Easy after-servicing**
 Disassembling and reassembling procedures and serviceability have been improved largely by:
 - employment of a new balance hair-spring holding device;
 - decrease in number of parts resulting from the simplification of the movement structure;
 - decrease in number of new parts resulting from interchangeability of some parts with Cal. 61 series.

3) Disassembling and reassembling

Disassembling procedures Figs.: ① ~ ⑤⑦
 Reassembling procedures Figs.: ⑤⑦ ~ ①
 The movement holder for 61 series is also used for disassembling and reassembling.

4) Lubrication

The following marks indicate the types of oil, and quantity to be applied and lubricating portions.

Type of oil

- Moebius A
- Moebius V
- SEIKO Watch Oil, S-2
- SEIKO Watch Oil, S-6

Oil quantity

- Liberal quantity
- Normal quantity
- Extremely small quantity

Note: Never lubricate the portions marked ⊗

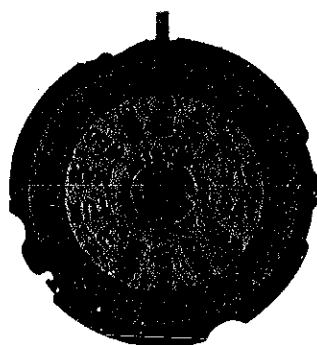
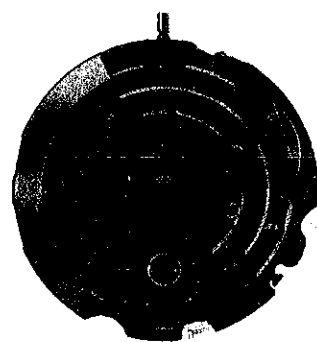

Movement

Holding ring for dial

As this holding ring for the dial incorporates the two functions of both the currently used holding ring for dial and the case ring, it simplifies the casing of the watch.

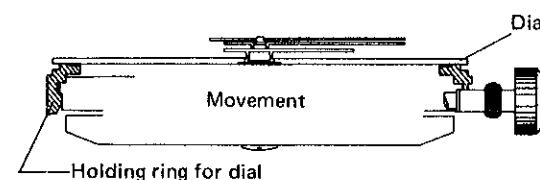

The holding ring for dial is generally classified into two types.

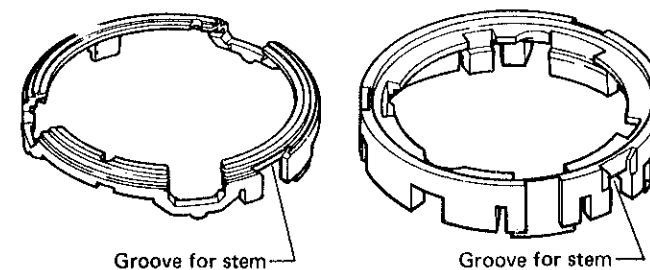

Note:

- The movement holder for 61 series cannot be used if the holding ring for dial is assembled with the movement, because the holding ring for dial touches when setting the movement into the movement holder as shown in the illustration. (The movement holder for 61 series can be used for the one-piece type case, square type case and case with dial ring.)

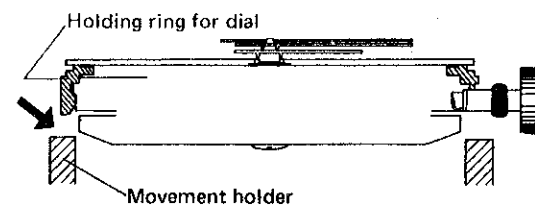

The holding ring for dial touches when setting the movement into the movement holder.

- Disassembling and reassembling of this holding ring for dial from the movement is a little different from that of the current holding ring for dial. Follow the procedures below.

Disassembling

- When the movement is to be removed from the case, pull out the winding stem and turn the case upside down. The movement should fall out. It is not necessary to pull up on the holding ring for dial.

- After loosening the dial screws, the dial and the holding ring for dial can be removed together. Put the tip of tweezers into the groove of the main plate located near the barrel and pry toward the arrow marked direction as shown in the illustration. Then the dial and the holding ring for dial will be removed together.

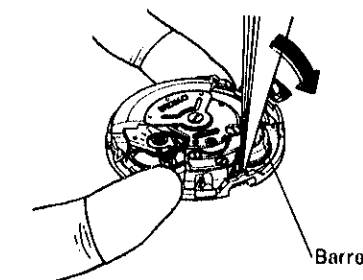

Reassembling

- Place the groove for the stem of the holding ring for dial upon the winding stem, and press down the holding ring for dial on the mainplate.
- Place the movement on a clean cloth when handling.

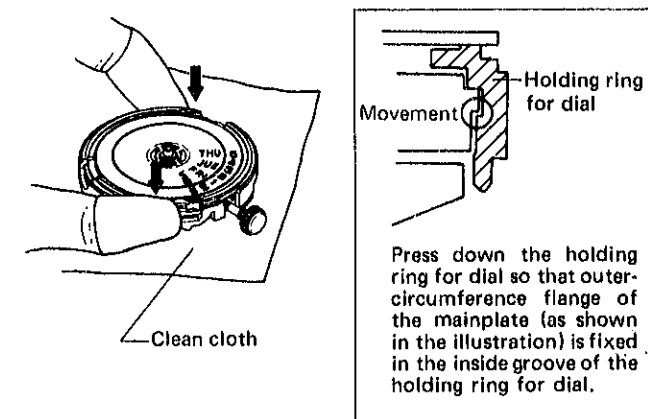

Hour, minute and second hands

Note for reassembling:

- When mounting the hands, place the movement on a clean cloth.

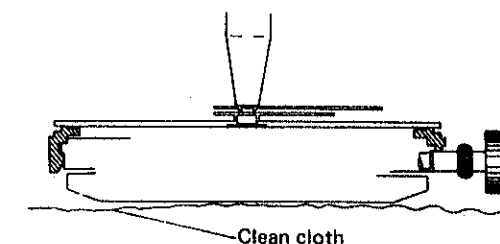

6309A Calendar mechanism

6309A Automatic winding mechanism, escapement and governor mechanism

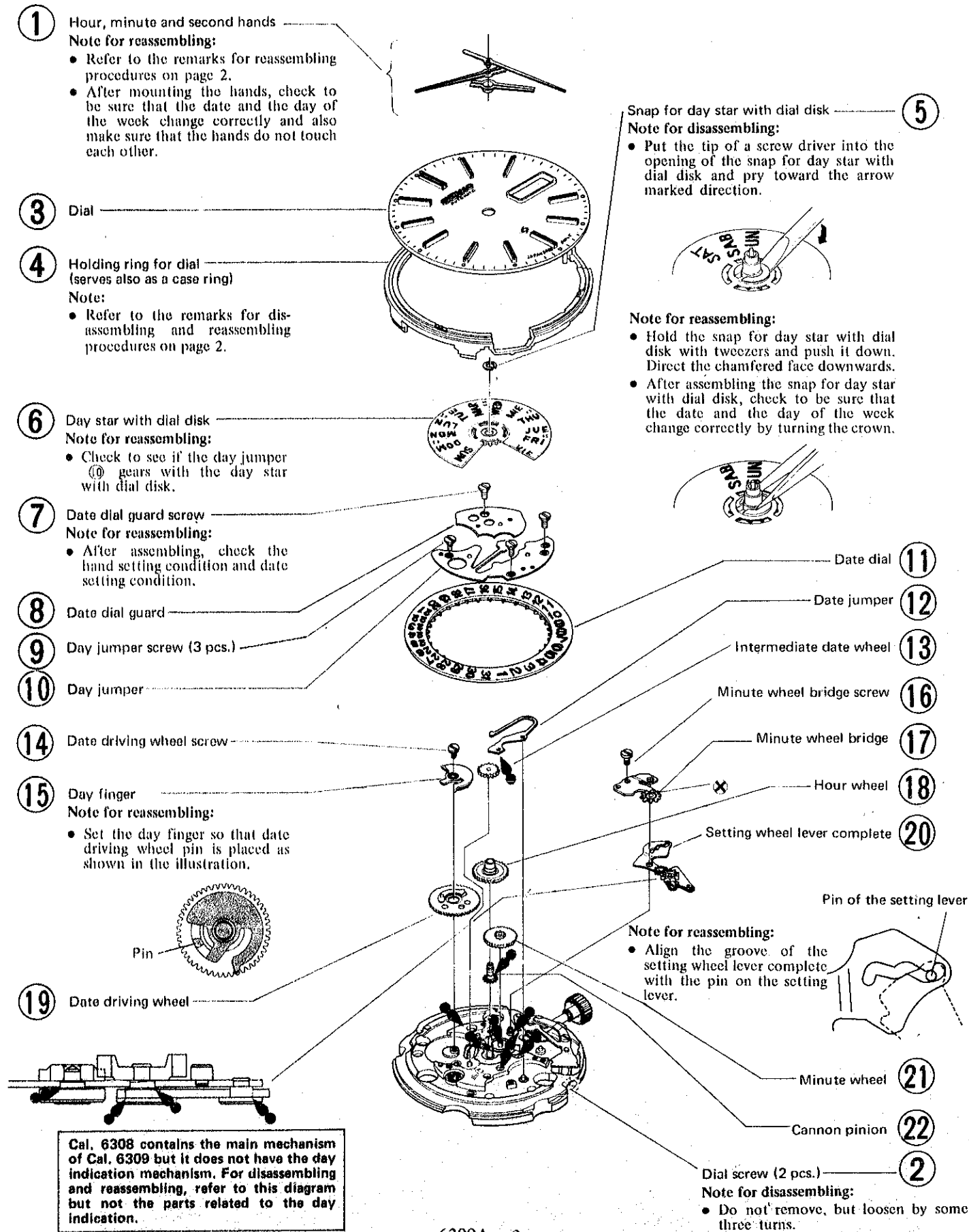

Cal. 6308 contains the main mechanism of Cal. 6309 but it does not have the day indication mechanism. For disassembling and reassembling, refer to this diagram but not the parts related to the day indication.

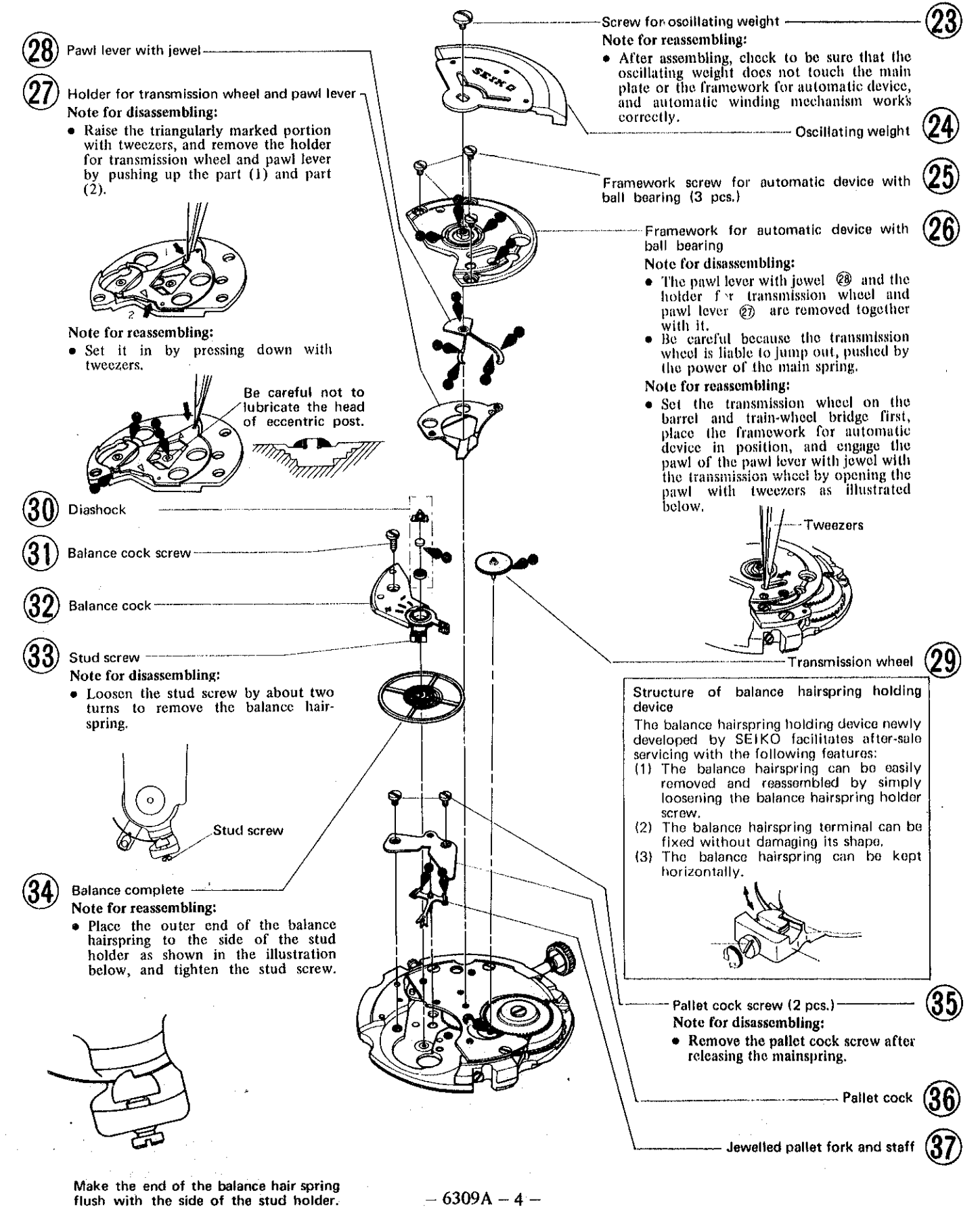

6309A Gear train mechanism

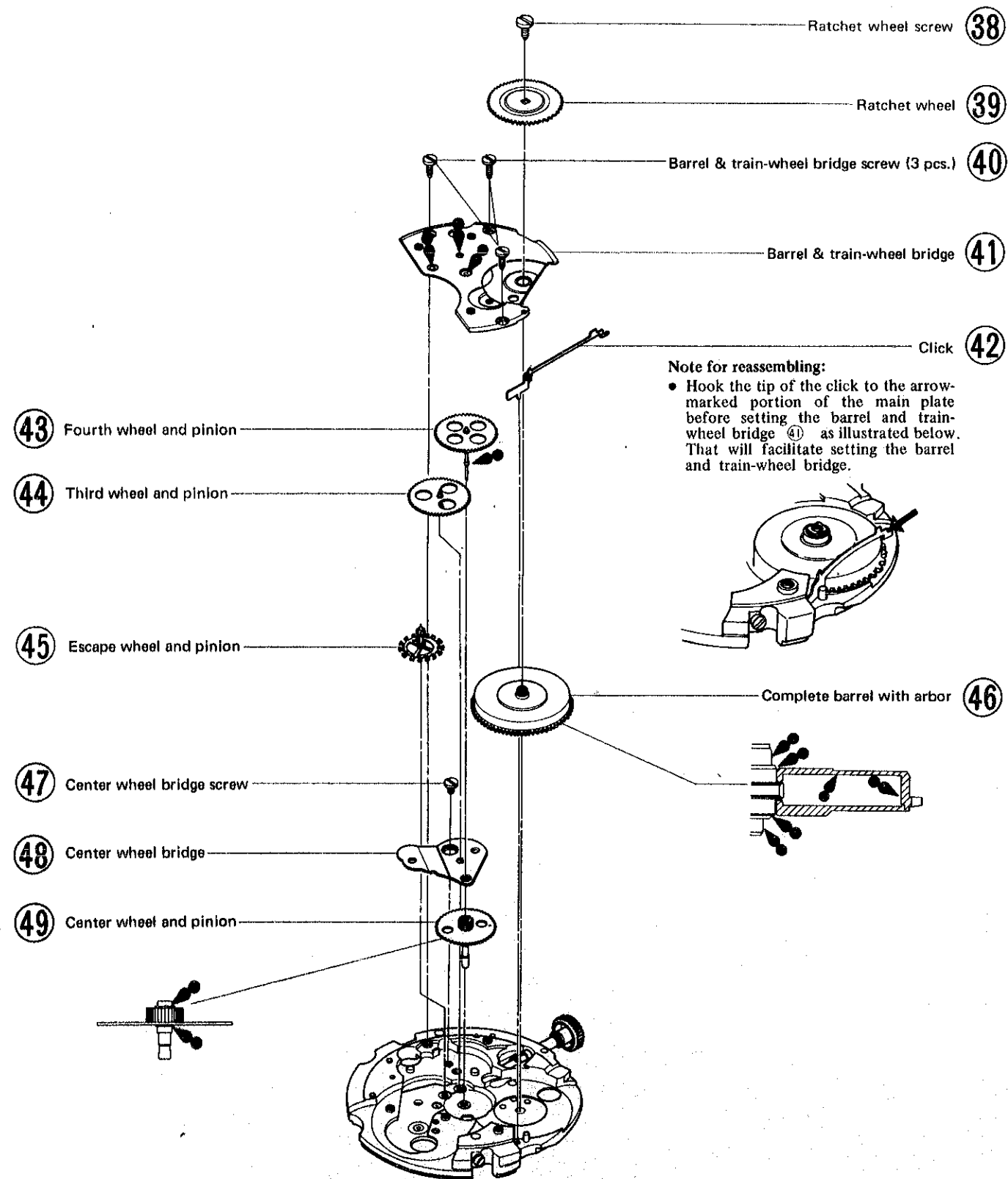

6309A Setting mechanism

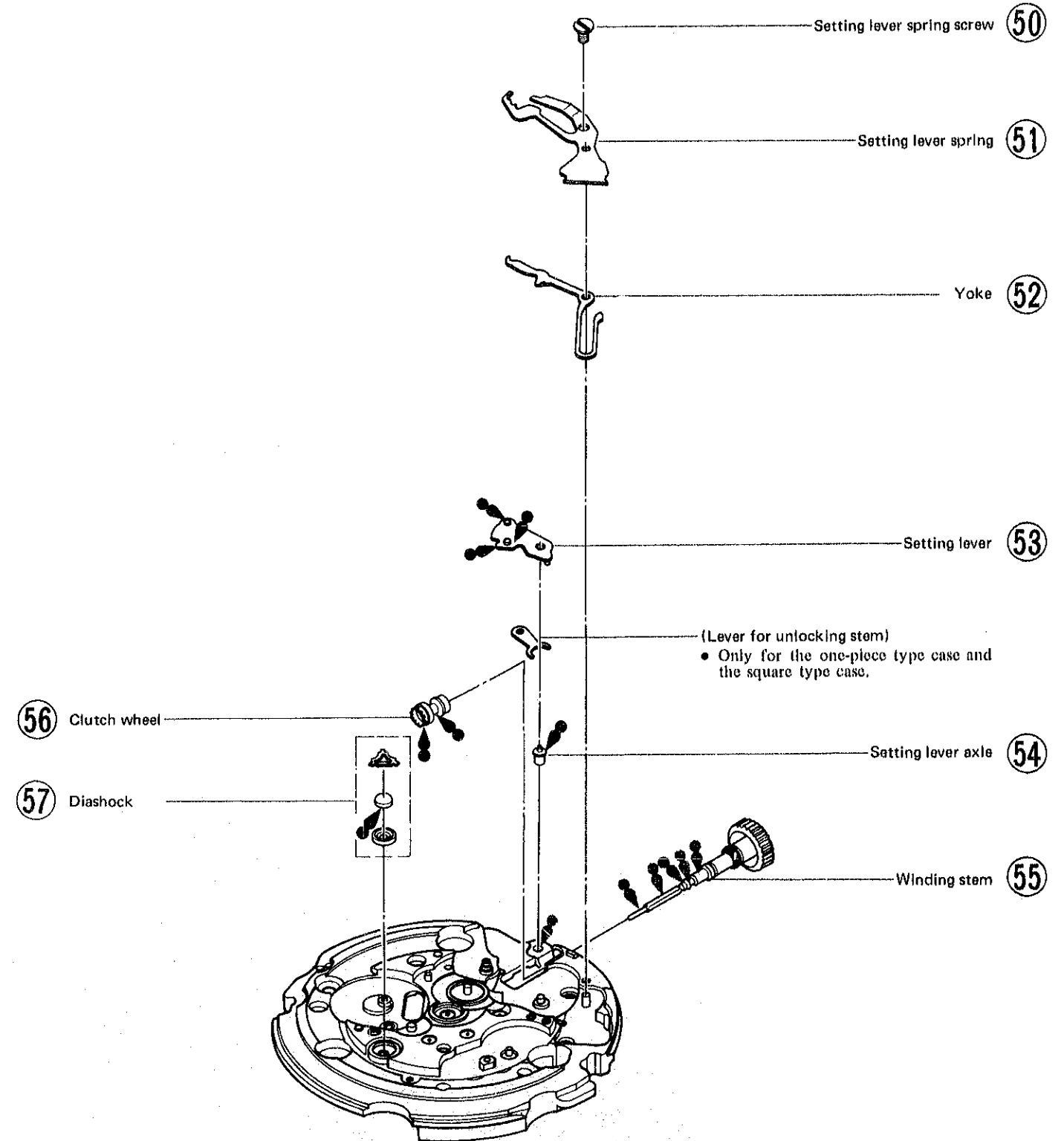

6309A Setting mechanism

Crown at the normal position (free)

The clutch wheel and the setting wheel do not gear with each other, and no power can be transmitted to the mainspring by turning the crown.

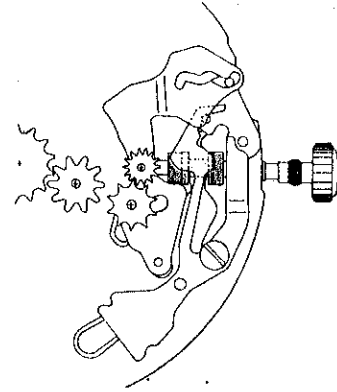

Crown at the first click position (for day/date setting)

(1) Clockwise turning (date setting)

Turn the crown clockwise, and the corrector wheel will move toward the date dial and it will gear with the date dial to correct the date.

The turning force is transmitted from the Crown, Clutch Wheel, Setting Wheel, Intermediate Setting Wheel, Corrector Wheel and Date Dial.

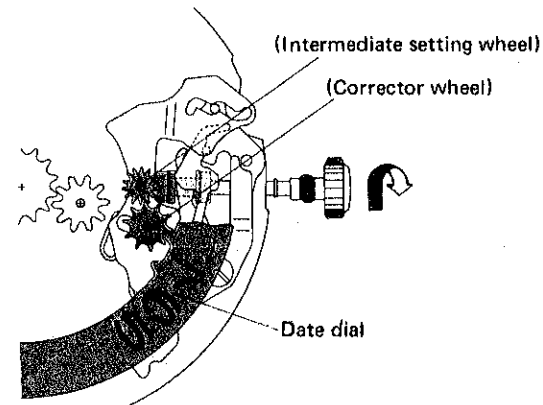

(2) Counterclockwise turning (day setting)

Turn the crown counterclockwise, and the corrector wheel will move toward the day star with dial disk and it will gear with the intermediate wheel for day correction to the day.

The turning force is transmitted from the Crown, Clutch Wheel, Setting Wheel, Intermediate Setting Wheel, Corrector Wheel, Intermediate Wheel for Day Correction and Day Star with Dial Disk.

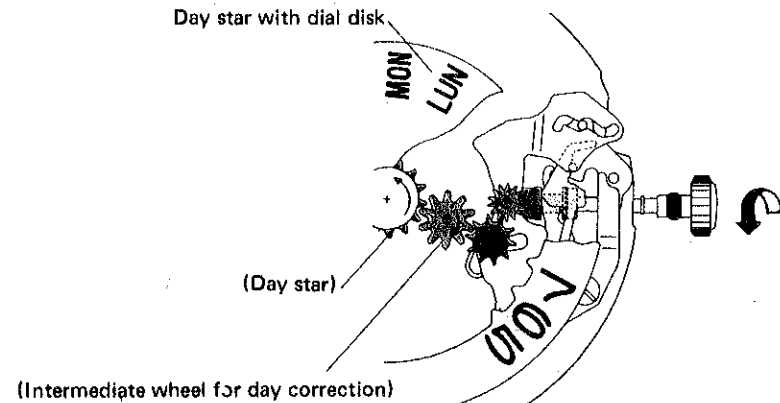

Crown at the second click position (for hand setting)

The setting wheel lever complete will move toward the minute wheel through the function of the setting lever and the intermediate setting wheel will gear with the minute wheel to set the hands.

At the same time, this motion of the setting wheel lever complete is transmitted to the day-date corrector wheel rocking lever and, the corrector wheel moves into a neutral position so that it will not gear with either the date dial and the intermediate wheel for day correction.

